

Trouvez les angles et les côtés

MATHS !!

NOM : _____

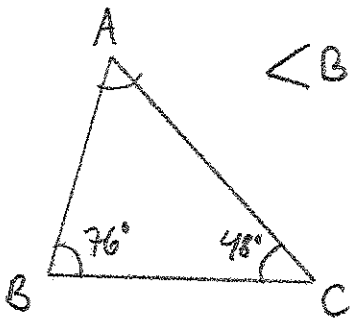

$\angle BAC =$ _____

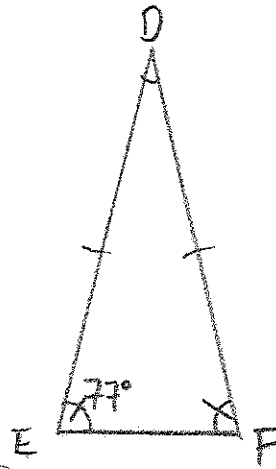

$\angle DFE =$ _____

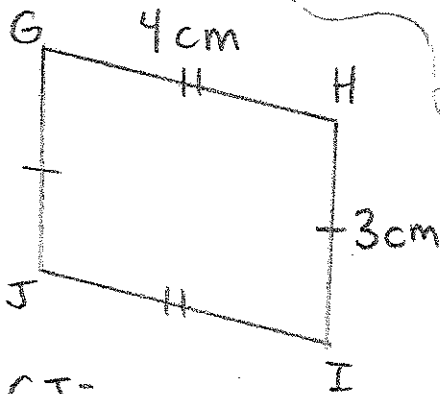

côté GJ = _____

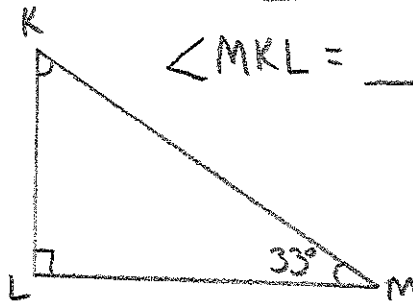

$\angle MKL =$ _____

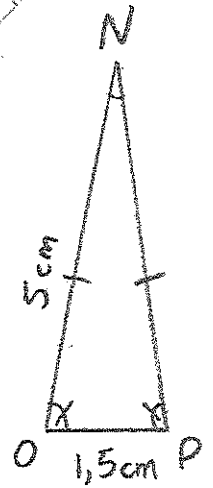

côté NP = _____

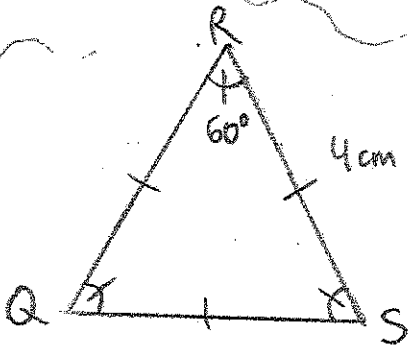

$\angle RQS =$ _____

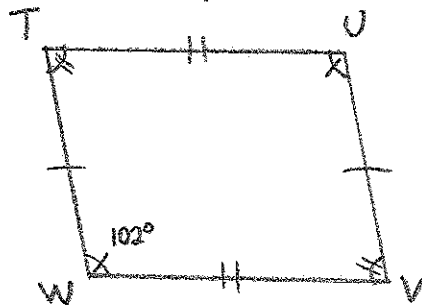

$\angle WTU =$ _____

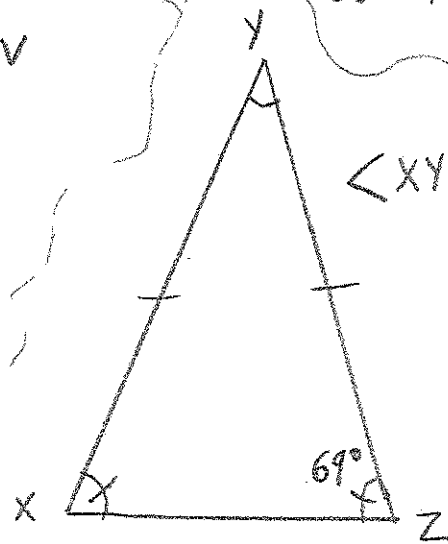

$\angle XYZ =$ _____

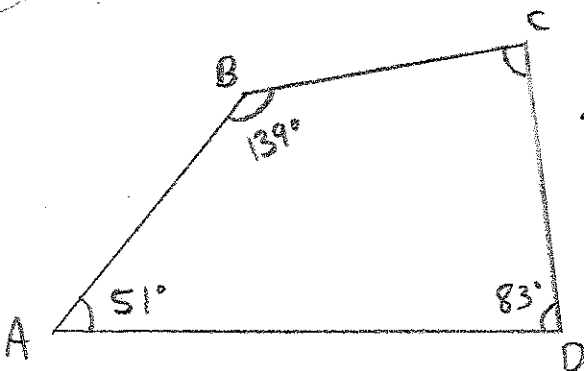

$\angle BCD =$ _____